

Regulatory requirements

- GITS®4 Software compliant with GAMP 5, CFR 21 Part 11 and EU Annex 11
- FDA and cGMP compliant
- ISO:9001 certified
- MK can help you to meet the Annex 1 glove leak testing requirements with minimum impact to your production schedules:
Integrity testing of the barrier systems, and leak testing of the glove system (...) performed minimum at the beginning and end of each batch is possible in an easy and fast way

Your solution to meet EU GMP Annex 1 changes

- Customizable to your port size
- 100% Made in Germany
- Easy cleaning, H₂O₂/VHP fumigable
- Complete qualification service
- Stand-alone or fully integrated system

Contact us

MK Versuchsanlagen GmbH & Co. KG

Stückweg 10 • 35325 Mücke

+49 6400 9576030

sales@mk-versuchsanlagen.de

www.mk-versuchsanlagen.de



Fully automatic glove tester

MK Glove Test Device Generation 3

Your solution to meet EU GMP
Annex 1 requirements



Easy to use

1 Insert Glove Test Device

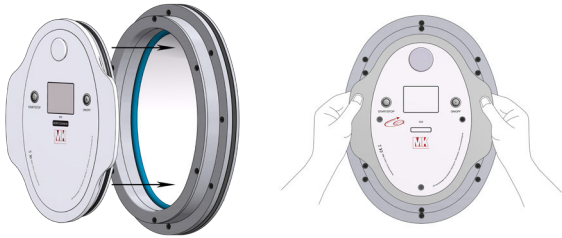

2 Turn on Glove Test Device

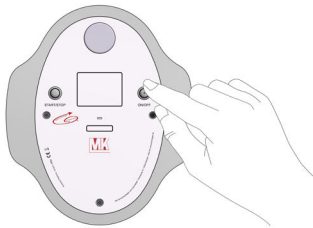
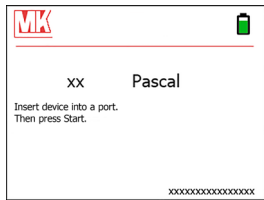

3 Start measurement

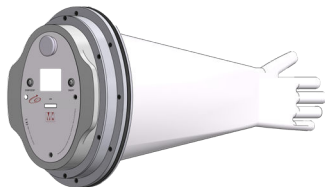
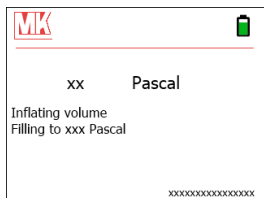

Features

Total test time

- From 5 minutes (depending on glove material and port size)

MK Glove Integrity Test System - GITS®

- Traceability of glove testing
- Port and glove recognition with integrated RFID technology
- Automatic machine validation and generated reports

MK Glove Life Cycle System - GLCS®

- Monitoring of glove aging process
- Recognize glove failure in advance
- Glove life cycle tracking, from inventory to sterilization, through testing to replacement

Accessories

Transportcase for smooth delivery (incl.)

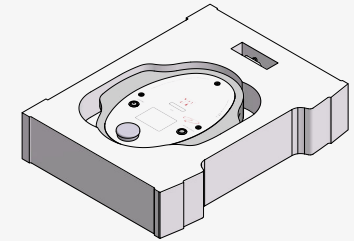

Inductive battery (incl.) and charging station

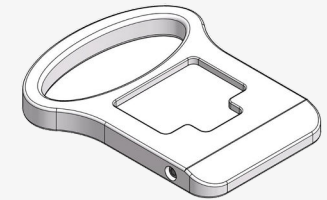

Service station for up to 15 Test Devices with included charging stations

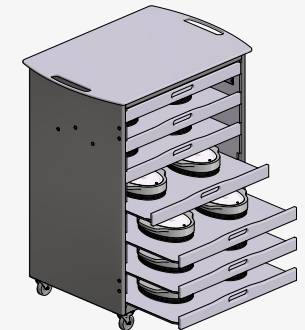

Services

- Specific Glove Test parameters
- Qualification services (IQ, OQ, PQ and more)
- Comprehensive service and maintenance
- WLAN site survey and planning